

110mm Pipe & Fittings BS 4660:2000, BS EN 1401-1:2009, BS EN 124:1994, BS 7158:2001

- **FloPlast** Socketed Underground Pipe incorporates the latest blown end technology. The easy fit rubber seal is held in place via a circular plastic insert allowing a retention of the seal in transit and a perfect connection for jointing.
- All Push-Fit underground fittings have a captive seal and snap cap which are designed to be user-friendly - no sharp edges, and with space restrictions in mind, allow for an easy fit connection. The seal is double ribbed, and the sockets incorporate a recessed area to provide space for the rubber seal to locate as the pipe is inserted, forming a high-capacity pressure point.



<small>BS EN 1401:2009 / BS 4660:2000 BS 7158:2001 / BS EN 124:1994</small>	110mm	160mm
Hepworth	✓	✓
Brett Martin	✓	✓
Osma/Wavin	✓	✓
Polypipe	✓	✓
Polypipe Terrain	✓	✓
Marley	✓	✓
Hunter	✓	✓



Pipe-Plain Ended

	SIZE	CODE
	3m	D043
	6m	D046



Bale Quantity - 50

Pipe-Single Socket

	SIZE	CODE
	3m	D143
	6m	D146





Bale Quantity - 50

Pipe Couplings



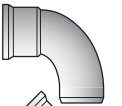



	CODE
 Single Socket	D124
 Double Socket*	D105

*Removable centre stop for use as Slip Coupling

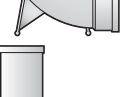

Single Socket Bends

	CODE
 87½° Bend (Socket/Spigot)	D161
 45° Bend (Socket/Spigot)	D163
 30° Bend (Socket/Spigot)	D164
 15° Bend (Socket/Spigot)	D167

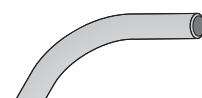

Double Socket Bends

	CODE
 87½° Bend	D561
 45° Bend	D563
 30° Bend	D564
 15° Bend	D567
 87½° Rest Bend	D571
 87½° Settlement Rest Bend	D570
 0-90° Adjustable Bend (PP- Do not solvent weld)	D560





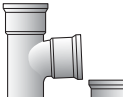
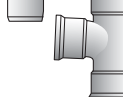



Long Radius Bends

	CODE
 87½° Plain end	D281
 45° Plain end	D283
 87½° PE with Channel Access	D581
45° PE with Channel Access	D583

Equal Junctions





	CODE
 87½° Junction (Double Socket)	D190
 45° Junction (Double Socket)	D210
 87½° Junction (Triple Socket)	D191
 45° Junction (Triple Socket)	D211

Access Fittings

	CODE
 87½° Access Bend (Socket/Spigot)	D169
 Access Pipe (Socket/Spigot)	D274
 Screwed Access Cap	D292
 Channel Access Pipe PE 1.5m	D870
 PVC Oval Rodding Point (Spigot)	D881
 PVC Oval Rodding Point (Socketed)	D882
 PVC Sq. Rodding Point (Spigot)	D883
 PVC Sq. Rodding Point (Socketed)	D884

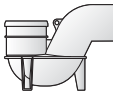
(45° rodding point with sealed access cover suitable for a loading up to 10 kN (1 tonne) where the frame of the cover is supported by a concrete plinth).

Universal Gully Traps

	CODE
 Universal Gully Trap (Socket/Spigot 45°)	D500
 Low Back 'P' Trap (Socket/Spigot 90°)	D501
 Leaf/Debris Interceptor (Black)	D94
 Spare Square Grid (Polypropylene)	D502
 Square Hopper incl' Polypropylene grid	D504
 Rectangular Hopper incl' Polypropylene Grid	D506

DrainGuard

	CODE
 DrainGuard (black) (Fits square & round downpipe)	DG1

110mm Pipe & Fittings BS 4660:2000, BS EN 1401-1:2009, BS EN 124:1994, BS 7158:2001

- Provides an efficient means of waste water drainage and foul discharge from above ground drainage systems.
- Manufactured in PVC-U to give a strong durable product, lightweight and easy to work with and suitable for high temperatures and waste discharge.
- Fittings have an aesthetic modern look, are compact in size yet remain within the British Standard specification.
- Push-Fit joint through an innovatively designed seal and snap cap system.
- Comprehensive range of fittings to suit most installations and which integrate with all FloPlast Above and Below Ground Drainage Systems.
- Colours available: Terracotta.









Ancillaries



800gm Lubricant Gel	CODE
Water Council Approved KIWA KM 51564 BS6209	SG800
100gm Silicone Grease	SG100
400ml Silicone Lubricant Spray	SL400
125ml Solvent Cement	SC125
250ml Solvent Cement	SC250



Bottle Gully Traps

	Bottle Gully Circular Grid	CODE D510
	Bottle Gully Rectangular Grid	D520
	Back Inlet Bottle Gully Rectangular Grid	D530
	Back Inlet Bottle Gully Circular Grid	D540
	Round Hopper & Grid (215mm Diameter with height adjustment of 32mm)	D514
	Rectangular Hopper & Grid (295mm x 216mm overall size with height adjustment of 32mm)	D524
	200mm Riser	D505



Adaptors

	110x50mm Waste Adaptor (Grey/Black)	CODE SP95
	110x68mm Rainwater Adaptor (Grey/Black)	SP96
	Universal Waste Adaptor (32/40/50mm)	D95
	Universal Rainwater Adaptor (Sq/Rd)	D96
	80x110mm Adaptor	D97
	160x110mm Level Invert (Socket/Spigot)	D99
	Supersleve Clay Adaptor (Black)	D100
	Hepsleve Clay Adaptor (Black)	D101

Drain Connector (Grey/Black)

	CODE SP107
--	---------------

Flexible Coupling and Adaptor





	SIZE Flexi-coupling 98mm -115mm	CODE D102
	Flexi-adaptor A = 98mm - 115mm B = 120mm - 136mm	D103
	End Cap 105mm -116mm	SP113

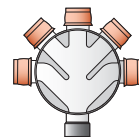
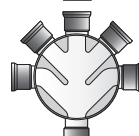

Socket Plug

	CODE D296
--	--------------

Large Inspection Chamber - 450mm Diameter (LIC)



	270mm deep Chamber Base - 5x110mm flexible inlets Supplied with 4 socket plugs (Allows for 0-20° of movement)	CODE D900
	270mm deep Chamber Base - 5x110mm fixed inlets Supplied with 4 socket plugs	D910
	235mm Extension Riser (can be cut to size)	D915
	Riser Sealing Ring (use with each Riser)	D935
	450mm screw down Plastic Cover & Frame (35 kN)	D930
	450mm Sealed screw down Plastic Cover & Frame with 350mm restricted access (for use with I.C. over 1.2mtr deep up to 3mtr) (35 kN)	D931



(To conform with new document H Building Regulations H2000 use D930 or D931 as required)

	Cast Iron Cover & Plastic Frame (35 kN)	D923
---	--	------

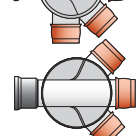
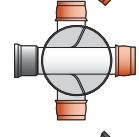
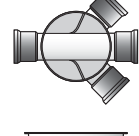
Mini Access Chamber - 300mm Diameter (MAC)

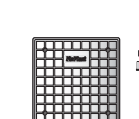
	270mm deep Multi inlet Chamber Base - 5x110mm flexible inlets supplied with four socket plugs (allows 0-20° of movement)	CODE D800
	270mm 45° inlet Chamber Base - 3x110mm flexible inlets supplied with two socket plugs (allows 0-20° of movement)	D801
	270mm 90° inlet Chamber Base - 3x110mm flexible inlets supplied with two socket plugs (allows 0-20° of movement)	D802
	270mm 45° inlet Chamber Base - 3x110mm fixed inlets supplied with two socket plugs	D810
	100mm Chamber Riser with integral rubber ring (60mm cut down facility)	D820
	200mm Chamber Riser with integral rubber ring (60/100/150mm cut down facility)	D822
	340mm Sealed Screw down cover and frame (35 kN)	D830